

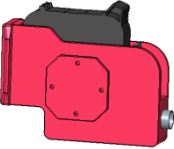

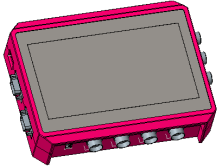







[1] 	[2] 	[3] 	[4] 	[5] 	[6] 	[7] 
Print Head	Touch screen controller	Bracket A (x2 pieces) Aperture 4.5	Bracket B(x1 pieces) Aperture 7.0	Bracket C (x2 pieces)	Sensor mounting block	M6 Allen driver
[8] 	[9] 	[10] 		[11] 	[12] 	
M4 Allen Driver	Photoelectric sensor	M4 screw(x4 pieces)		Square nut (x2 pieces)	Aluminium tube(x3 pieces)	

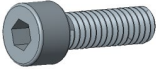
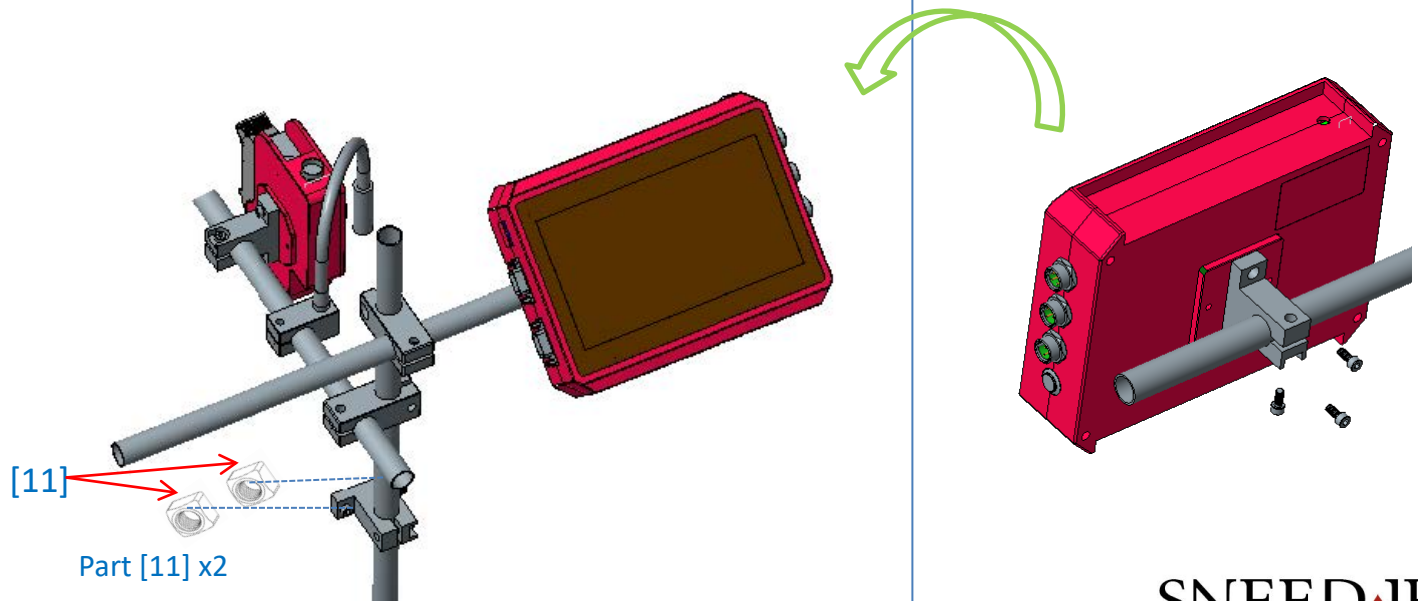

SNEED JET
TITAN